

Register your product and get support at  
[www.philips.com/welcome](http://www.philips.com/welcome)

## VOICE TRACER

LFH0612

LFH0617

LFH0632

LFH0633



EN User manual

**PHILIPS**

---

# Table of contents

---

<b>1</b>	<b>Welcome</b>	<b>3</b>	<b>6</b>	<b>Playback</b>	<b>11</b>
	Product highlights	3		Playback of a recording	11
<hr/>					
<b>2</b>	<b>Important</b>	<b>4</b>			
	Safety	4			
	Hearing safety	4			
	Disposal of your old product	4	<b>7</b>	<b>Delete</b>	<b>13</b>
<hr/>					
<b>3</b>	<b>Your Voice Tracer digital recorder</b>	<b>5</b>	<b>8</b>	<b>Customize settings</b>	<b>14</b>
	What's in the box?	5			
	Overview	6			
<hr/>					
<b>4</b>	<b>Get started</b>	<b>7</b>	<b>9</b>	<b>Update the firmware</b>	<b>16</b>
	Insert the battery	7			
	Power on/off	7			
	Keypad lock (HOLD function)	7			
	Using the Voice Tracer with a computer	8	<b>10</b>	<b>Frequently asked questions</b>	<b>17</b>
<hr/>					
<b>5</b>	<b>Record</b>	<b>9</b>	<b>11</b>	<b>Technical data</b>	<b>18</b>
	Record with the built-in microphone	9			
	Record with an external microphone	10			
	Add index marks	10			

---

# 1 Welcome

Congratulations on your purchase and welcome to Philips! To fully benefit from the support that Philips offers, visit our Website for support information such as user manuals, software downloads, warranty information and more:

**[www.philips.com](http://www.philips.com)**

---

## Product highlights

- ClearVoice – for dynamic enhancement of quiet recording passages giving excellent speech intelligibility
- Instant one-touch recording – from power off to recording with a single key press
- Record in the popular MP3 format
- Speedily transfer recordings and data via high-speed USB 2.0
- Voice-activated recording for hands-free note taking
- USB mass storage ensures maximum compatibility
- Organize recordings quickly and easily with four file folders

---

## 2 Important

---

### Safety

- To avoid a short circuit, do not expose the product to rain or water.
- Do not expose the device to excessive heat caused by heating equipment or direct sunlight.
- Protect the cables from being pinched, particularly at plugs.
- Back up your files. Philips is not responsible for any loss of data.

---

### Hearing safety

#### Observe the following guidelines when using your headphones:

- Listen at reasonable volumes for reasonable periods of time.
- Be careful not to adjust the volume higher as your hearing adapts.
- Do not turn up the volume so high that you can't hear what's around you.
- You should use caution or temporarily discontinue use in potentially hazardous situations.
- Do not use headphones while operating a motorized vehicle, cycling, or skateboarding, etc. It may create a traffic hazard and is illegal in many areas.

---

### Important (for models supplied with headphones):

Philips guarantees compliance with the maximum sound power of its audio players as determined by relevant regulatory bodies, but only with the original model of provided headphones. If these headphones need replacement, we recommend that you contact your retailer to order a Philips model identical to that of the original.

---

### Disposal of your old product

- Your product is designed and manufactured with high quality materials and components that can be recycled and re-used.
- When this crossed-out wheeled bin symbol is attached to a product, it indicates that the product is covered by the European Directive 2002/96/EC.
- Become informed about your local separate collection system for electrical and electronic products.
- Act according to your local rules and do not dispose of old products with normal household waste. The correct disposal of old products will help prevent potential negative consequences for the environment and human health.
- Batteries (including built-in rechargeable batteries) contain substances that may pollute the environment. All batteries should be disposed of at an official collection point.



---

## 3 Your Voice Tracer digital recorder

---

### What's in the box?

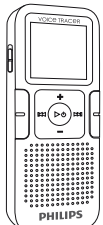

Digital recorder



Quick start guide



1 × AAA battery



USB cable

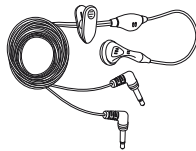

Hands-free headset (LFH0632/LFH0633 only)

## Overview

- ① Record/play indicator
- ② Display
- ③ Hold switch
- ④ Index, Folder, Repeat (**INDEX/■**)
- ⑤ Fast rewind, File selection, Set menu option (**⏮**)
- ⑥ Menu (**MENU**)
- ⑦ Power on/off, Play/Pause, Play speed (**▶ ⏸**)
- ⑧ Speaker
- ⑨ Strap hole
- ⑩ Volume up, Menu item selection (**+**)
- ⑪ Record, Pause, Power On (**● / ||**)
- ⑫ Fast forward, File selection, Set menu option (**⏭**)
- ⑬ Stop, Display, Delete (**■ / DEL**)
- ⑭ Volume down, Menu item selection (**-**)
- ⑮ Microphone jack (**MIC**)
- ⑯ USB socket
- ⑰ Headphones jack (**EAR**)
- ⑱ Integrated microphone

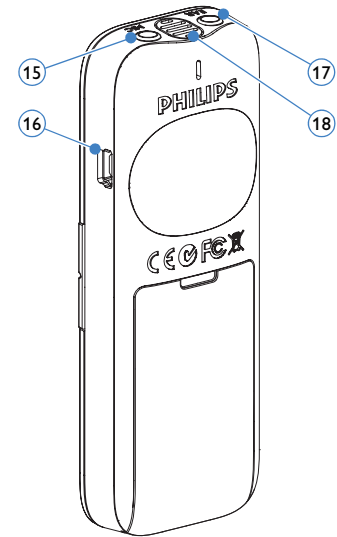
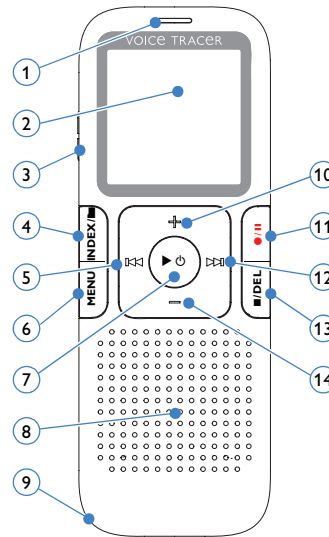

## 4 Get started

### Insert the battery

- 1 Slide open the battery cover.
- 2 Insert the battery as indicated. Make sure the polarity is correct.

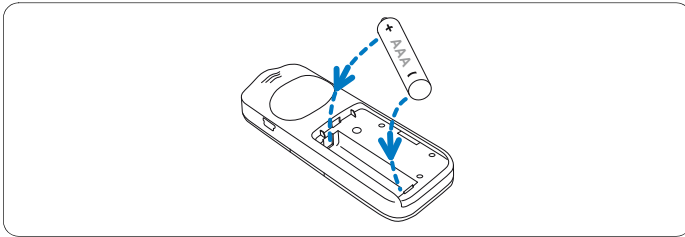

- 3 Close the cover again.

### ⊖ Notes

- Remove the battery if you will not be using the Voice Tracer for an extended period. The Voice Tracer could be damaged by a leaking battery.
- If the Voice Tracer does not function properly, remove the battery and re-insert it again.
- Stop the Voice Tracer before replacing the battery. Removing the battery while the recorder is in use may corrupt the file.
- When the battery is nearly empty, the battery indicator blinks.

### Power on/off

- 1 To power on, press the ► ⏻ button until the display shows a short animation [ ].
- 2 To power off, press the ► ⏻ button while the recorder is stopped until the display shows BYE.

### Keypad lock (HOLD function)

- 1 Slide the **HOLD** switch up into the Hold position to lock the keypad of the recorder.
  - The display briefly shows 'On Hold' and turns off.

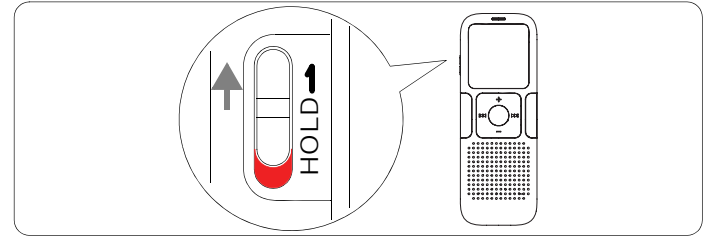

- 2 Slide the **HOLD** switch down to the Off position to disengage the keypad lock.

---

## Using the Voice Tracer with a computer

As a USB mass storage device, the Voice Tracer offers a convenient way to save, back up and move files. The Voice Tracer connects to a computer using a USB connection and does not require special software to be installed. The Voice Tracer is automatically displayed as a removable drive.

### Notes

- Do not disconnect the Voice Tracer from the computer while files are transferred from or to the recorder. The record/play indicator  flashes orange, when data is being transferred.

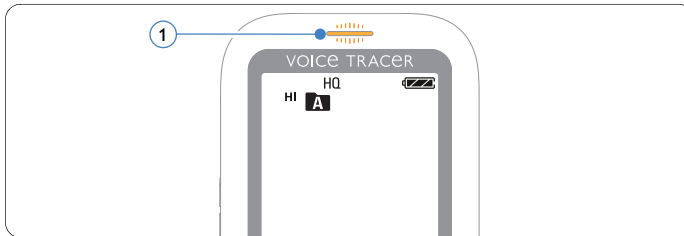

- Do not format the drive of the Voice Tracer on a computer. Formatting on the Voice Tracer uses the correct file system and automatically creates the required folders.



---

## 5 Record

Please note the instructions in this section when you make the first recording with your Voice Tracer!

---

### Record with the built-in microphone

- 1 Press the **INDEX/■** button while the recorder is stopped to select the desired folder.
- 2 Press the **●/||** button to start recording.
  - The record/play indicator lights red.
  - Point the built-in microphone toward the sound source.
- 3 To pause recording, press the **●/||** button.
  - The record/play indicator will blink, and PAUSE will flash on the display.
- 4 Press the **●/||** button again to resume recording.
- 5 To stop recording, press the **■/DEL** button.

### ⊖ Notes

- Set the desired voice activation function and recording mode before starting recording (see *chapter 8, Customize settings on page 14* for more information).
- Make a test recording to make sure that the Voice Tracer settings are correct.
- Press and hold **▶ ⊕** during recording to display the remaining recording time.
- Press **▶▶** during recording to create a new file.
- The maximum number of files in each folder is 99, for a total capacity of 396 files (99 files × 4 folders).
- If the recording time exceeds the available capacity or the number of files reaches 396, recording stops and **FULL** will be displayed. Delete a few recordings or move them to a computer.
- Do not remove the battery when recording is in progress. This can cause the unit to malfunction.
- If you are to start a long recording session, replace the batteries before you begin.

---

## Record with an external microphone

To record with an external microphone, connect the microphone to the microphone jack and follow the same procedure as for the built-in microphone. The built-in microphone is switched off when an external microphone is connected.

---

## Add index marks

Index marks can be used to mark certain points in a recording as points of reference (for example, to mark the start of a new subject of discussion).

- 1 Press the **INDEX**/ button during recording to add an index mark.
  - *The index number is displayed for one second.*

## Notes

- The index icon **INDEX** ① indicates that the recording contains index marks.

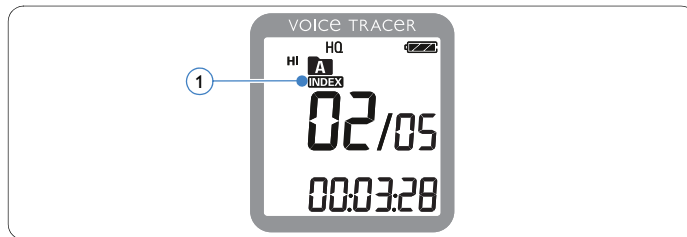

- Up to 32 index marks can be set per file.

## 6 Playback

### Playback of a recording

- 1 Press the **INDEX/■** button while the recorder is stopped to select the desired folder.
- 2 Press the **◀◀** or **▶▶** button to select the file to play back.
- 3 Press the **▶ ⏻** button.
  - The playback time will be shown on the display, and the record/play indicator will light green.
- 4 Adjust the volume using the **+** and **-** buttons.
- 5 To stop playback, press the **■/DEL** button.
  - The total playback time of the current file will be shown on the display.
- 6 Press the **▶ ⏻** button again to continue playback from the previous position.

### ⊖ Notes

When headphones are connected to the headphones jack, the recorder speaker will be switched off.

### Playback functions

#### Selecting a file

- 1 While the recorder is stopped, press button **▶▶** briefly to jump to the start of the next file.

- 2 While the recorder is stopped, press button **◀◀** briefly to jump to the start of the previous file.

### Slow, fast, normal playback

- 1 Press and hold the **▶ ⏻** button for one second or longer to switch between normal, slow **||▶** and fast **||▶▶** playback ①.



### Search

- 1 Press and hold the **◀◀** or **▶▶** button during playback to scan backward or forward in the current file at a fast speed.
- 2 Release the button to resume playback at the selected speed.

## Rewinding and forwarding / searching for an index mark

- 1 Press the **◀◀** or **▶▶** button during playback to rewind to the beginning of the file being played or forward to the next file. If the file contains index marks, playback starts at the next index mark.

## Repeated playback

You can set the Voice Tracer to play files repeatedly.

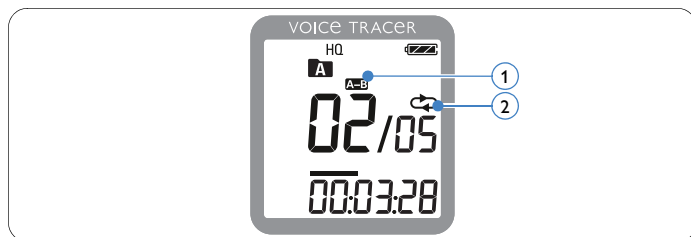

## Repeat a sequence

- 1 To repeat or loop a sequence in a file, press the **INDEX/■** button at the chosen start point.
  - The symbol **A-B** ① on the display flashes and the loop symbol  ② appears.
- 2 Press the **INDEX/■** button again at the chosen end point.
  - The repeat sequence begins.
- 3 Press the **■/DEL** button to stop playback or press the **INDEX/■** button to resume normal playback.



## Repeat a file or folder

- 1 Press and hold the **INDEX/■** button for one second or longer during playback to switch between play modes (repeat file or repeat folder).
- 2 Select the desired playback mode.



Icon	Description
	Repeat a file.
	Repeat all files in a folder.

---



## 7 Delete

---

### Deleting files and index marks

- 1 Press the **INDEX**/ button while the recorder is stopped to select the desired folder.
- 2 Press and hold the /**DEL** button for one second or longer.
  - *DELETE* appears on the display.
- 3 Press the **◀◀** or **▶▶** button to select a delete option:

Icon	Description
<b>FILE</b>	Delete a single file.
<b>FOLDER</b>	Delete all files in a folder.
<b>INDEX</b>	Delete all index marks in a file.

- 4 Press the **▶**  button.
- 5 Press the **◀◀** or **▶▶** button to select the file, the folder or the file containing the index marks to be deleted.
- 6 Press button **▶**  again.
  - *NO* appears.
- 7 Push button **◀◀** or **▶▶** to select **YES**.
- 8 Press the **▶**  button to confirm.

#### Note





The files will be automatically renumbered.



## 8 Customize settings

You can customize the settings of your Voice Tracer to suit the recording conditions and your personal preferences.

- 1 Press the **MENU** button while the recorder is stopped.
  - The display shows *MODE* and the current setting for recording mode is flashing.
- 2 Press the **+** or **-** button to navigate the setting icons bar up or down.
- 3 Press the **◀◀** or **▶▶** button to change the displayed setting. The new setting is automatically accepted (exceptions: the **FORMAT** and **SPLIT** functions must be confirmed by pressing the **▶** button).
- 4 Customize settings as required or exit the menu by pressing the **MENU** button.

Icon/Display	Option	Description
SLP LP SP HQ		Choose among several recording modes including HQ, SP, LP or SLP for a longer recording time. Refer to <i>chapter 11, Technical data</i> on page 18 for details.
 MIC	HI LO	Adjust the recording sensitivity to avoid recording background noises and to adjust to the recording environment.

Icon/Display	Option	Description
 VA	On Off	Voice-activated recording is a convenience feature for hands-free recording. When voice-activated recording is enabled, recording will start when you begin speaking. When you stop speaking, the recorder will automatically pause recording after three seconds of silence, and resume only when you begin speaking again.
 CLVOICE	On Off	Dynamic emphasis on quiet passages to improve the intelligibility of quiet voices.
 BEEP	Yes No	The recorder gives sound feedback about button operations or errors.
 AUTOOFF	5 15	The Voice Tracer automatically turns off after 5 or 15 minutes of inactivity

Icon/ Display	Option	Description
 FORMAT	No Yes	Delete all files on the recorder. Transfer important files to a PC before formatting the memory. Press ► ⏻ to confirm the selection.
 INFO		Display the firmware version and the release date. Example: 100 06/01/2010

---

## 9 Update the firmware

Your Voice Tracer is controlled by an internal program called firmware. As a part of ongoing product maintenance, the firmware is revised and errors are corrected.

It is possible that a newer version (an "update") of the firmware has been issued since you purchased the Voice Tracer. In this case you can easily update your recorder to the latest version.

- 1 Connect the Voice Tracer to your computer using the supplied USB cable.
- 2 Download the firmware update for your Voice Tracer from [www.philips.com](http://www.philips.com) onto your computer.
- 3 Copy the new firmware file to the root directory of the Voice Tracer.
- 4 Disconnecting the Voice Tracer from the computer automatically updates the firmware.

### Notes

- Please note that the firmware file must be located in the root directory to allow automatic updating.
- The firmware file will be deleted automatically after the update has been carried out. The Voice Tracer will then switch off.



---

## 10 Frequently asked questions

The answers to frequently asked questions listed here are intended to solve simple problems with the Voice Tracer. If you have no success please contact your dealer or visit our website:

**[www.philips.com/support](http://www.philips.com/support)**

---

### **My Voice Tracer cannot power on.**

- The battery is flat or has been inserted incorrectly. Replace the battery with a new one and make sure that it is inserted correctly.
- 

### **My Voice Tracer does not record anything.**

- The Voice Tracer is in HOLD mode. Slide the HOLD switch to the "Off" position.
  - The maximum number of recordings may be reached or the recording capacity is full. Delete some recordings or move recordings to an external device.
- 

### **I cannot hear anything from the speaker.**

- The headphones may be plugged in. Remove the headphones.
  - The volume is at the lowest setting. Adjust the volume.
- 

---

### **My Voice Tracer cannot play recordings.**

- The Voice Tracer is in HOLD mode. Slide the HOLD switch to the "Off" position.
  - The battery is flat or has been inserted incorrectly. Replace the battery with a new one and make sure that it is inserted correctly.
  - Nothing has been recorded yet. Check the number of recordings.
- 

### **My Voice Tracer cannot stop, pause, play or record.**

- The Voice Tracer is in HOLD mode. Slide the HOLD switch to the "Off" position.
- 

### **I cannot hear anything through the headphones.**

- The headphones may not be plugged in properly. Plug in the headphones properly.
  - The volume is at the lowest setting. Adjust the volume.
-

---

## 11 Technical data

### Connectivity

---

Headphones jack	3.5 mm Impedance: 16 $\Omega$ or above
Microphone jack	3.5 mm Impedance: 2.2 k $\Omega$
USB	High-speed USB 2.0, mini USB port

### Display

---

Type	LCD / segment
Screen size	34.5 mm / 1.4 "

### Memory

---

Built-in memory capacity	1 GB
Built-in memory type	NAND Flash
Mass storage class compliant	yes

### Recording

---

Format	MPEG1 Layer 3 (MP3)
Microphone	built-in high-sensitivity microphone, mono
Recording modes	HQ, SP, LP, SLP (MP3/mono)
Bit rate	HQ: 64 kbit/s SP: 48 kbit/s LP: 32 kbit/s SLP: 8 kbit/s
Recording time (approx.)	SLP: 277 hours LP: 70 hours SP: 46 hours HQ: 35 hours
Sample rate	HQ: 22 kHz SP/LP/SLP: 16 kHz

## Speaker

---

Type	built-in dynamic speaker
Diameter	23 mm / 0.9 "
Output power	110 mW
Sound enhancement	ClearVoice

## Battery

---

Type	AAA/LR03 Alkaline
Number of batteries	1
Lifetime	up to 15 (LFH0632/LFH0633: 22) hours (in SLP recording mode)

## System requirements

---

Operating system	Windows 7/Vista/XP/2000, Mac OS X, Linux
Interface	available USB port

## Operating conditions

---

Temperature	5° – 45°C / 41° – 113°F
Humidity	10% – 90%, non-condensing

## Dimensions and weight

---

Width × height × depth	38 × 105 × 16.4 mm / 1.5 × 4.1 × 0.6 "
Weight incl. battery	55 g / 0.12 lb



Specifications subject to change without notice.

Trade marks are the property of Royal Philips Electronics or their respective owners.

© 2010 Royal Philips Electronics. All rights reserved.

Document version 2.0, 08/08/2010.